

# scorrevole a libro con struttura perimetrale

sliding folding systems with frame structure

Glas falt Schiebewände mit Rahmenstruktur

L-2000

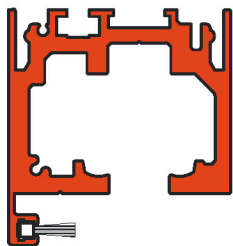
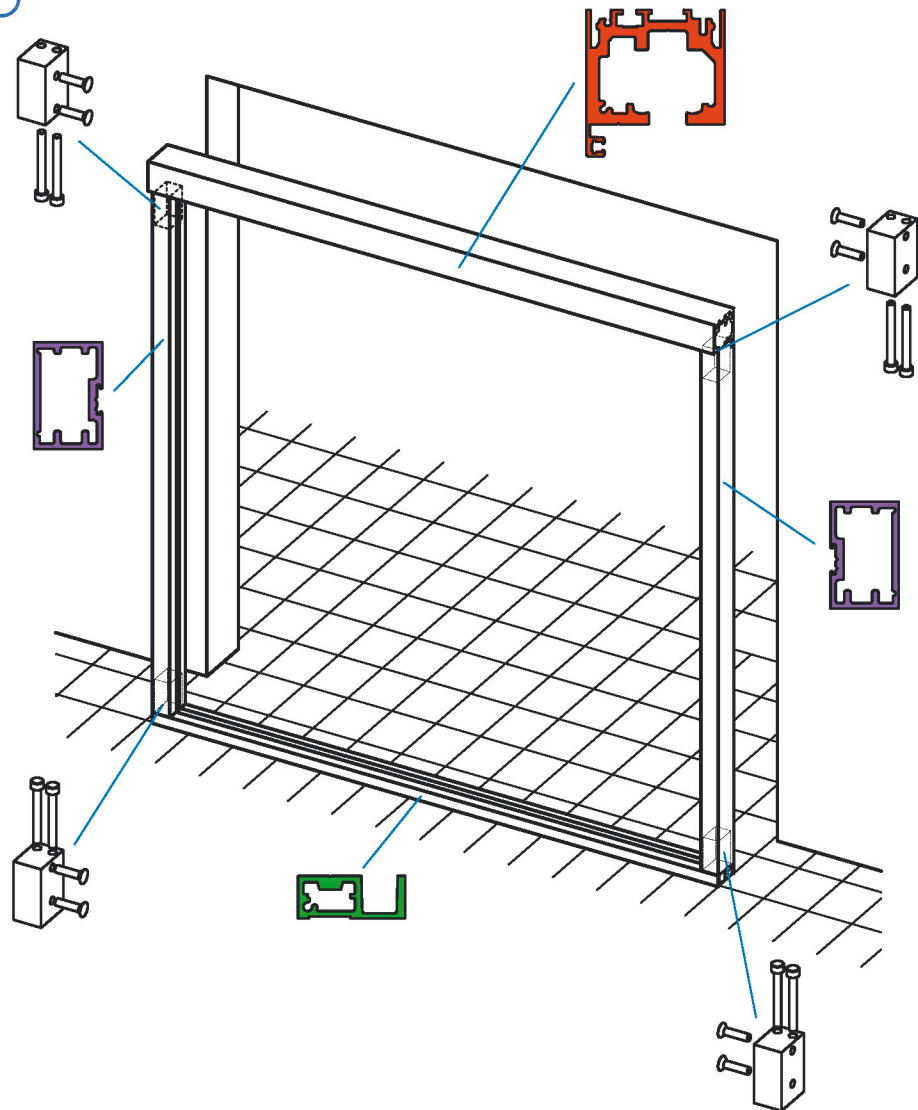

## L-200

Binario superiore di scorrimento in alluminio anodizzato con spazzola  
Anodised aluminium top track profile with brush seal  
Eloxiertem Aluminium  
Laufschienenprofil mit Bürstenprofil

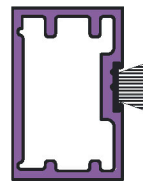

## L-211

Profilo montante in alluminio anodizzato  
Side profile in anodised aluminium  
Seitliches Profil aus eloxiertem Aluminium



## L-210

Guida inferiore in alluminio anodizzato  
Bottom guide channel in anodised aluminium  
Bodenführung aus eloxiertem Aluminium

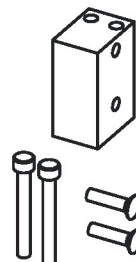

## L-212

Blocco fissaggio angoli struttura  
Fixing corner set  
Eckbefestigung Set





INGRESSO  
↑

# scorrevole a libro L-2000

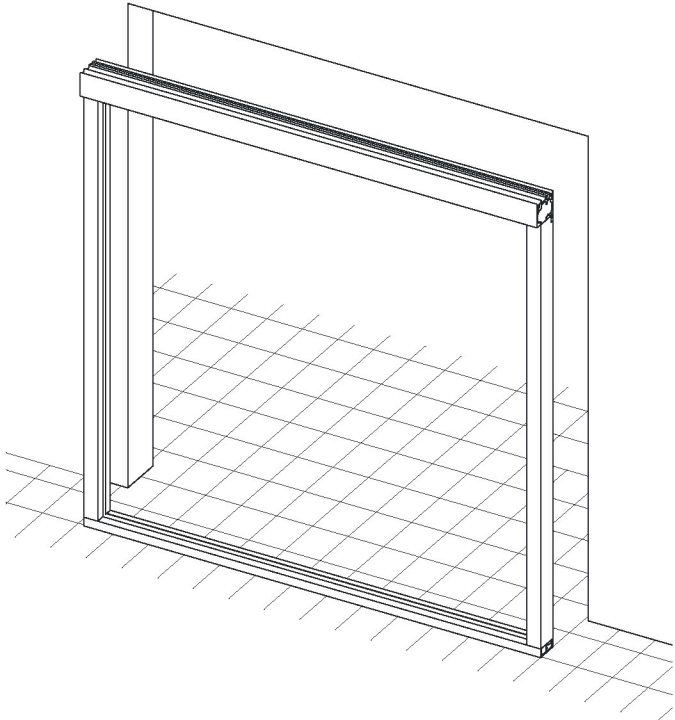
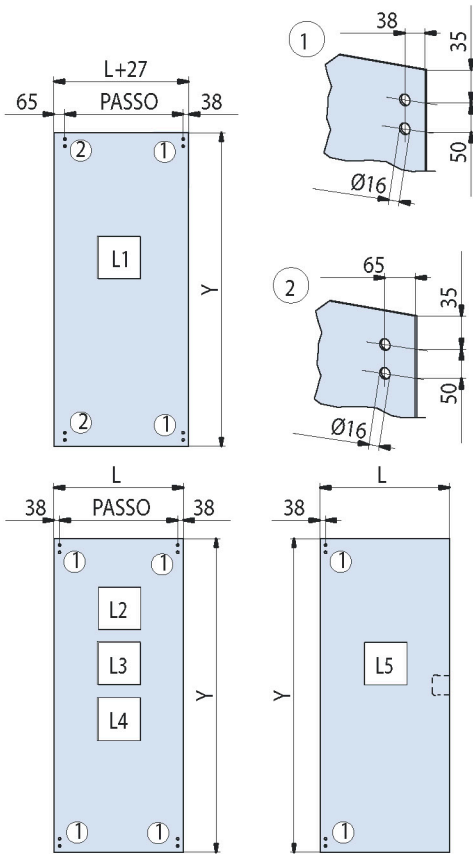

LUCE LARGHEZZA PASSAGGIO TOTALE (Lp) = (Lm) LARGHEZZA VANO MURO - (32x2)

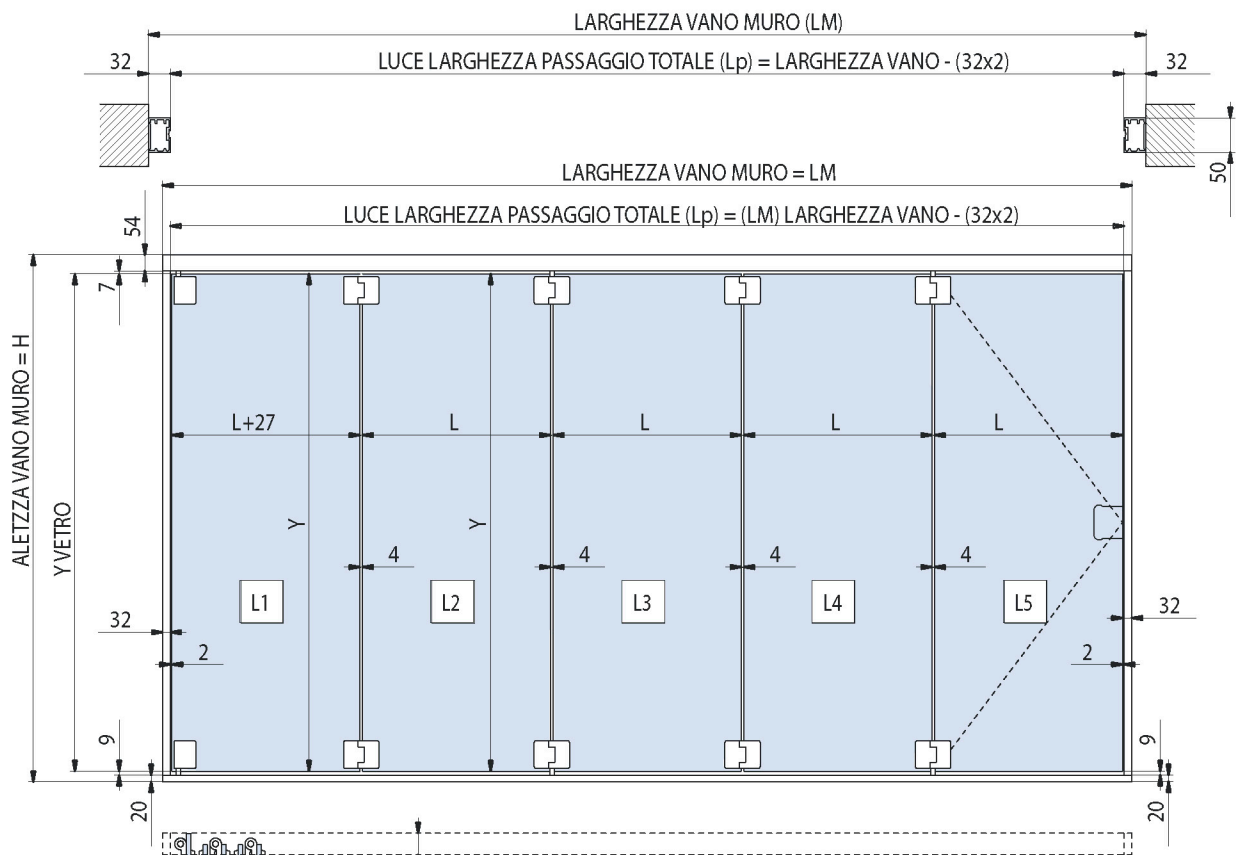

Y = Altezza vetro  
Glass height  
Glashöhe

H = Altezza vano muro  
Opening height  
Einbaulichte Höhe

Lp = Luce larghezza passaggio totale  
Clear opening width  
Lichte durchgangsbreite

Lm = Larghezza vano muro  
Opening width  
Einbaulichte Breite

# scorrevole a libro L-20000

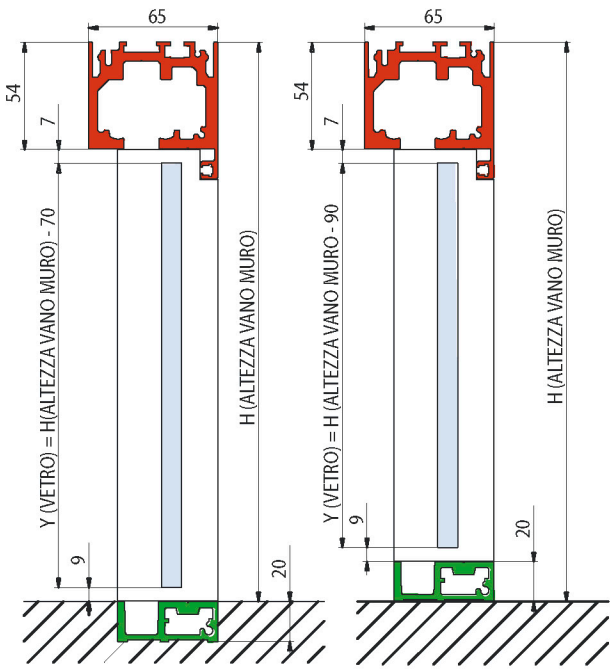
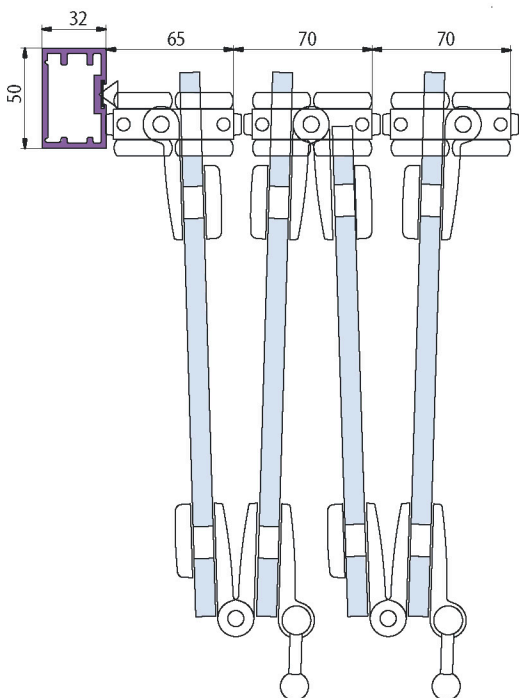
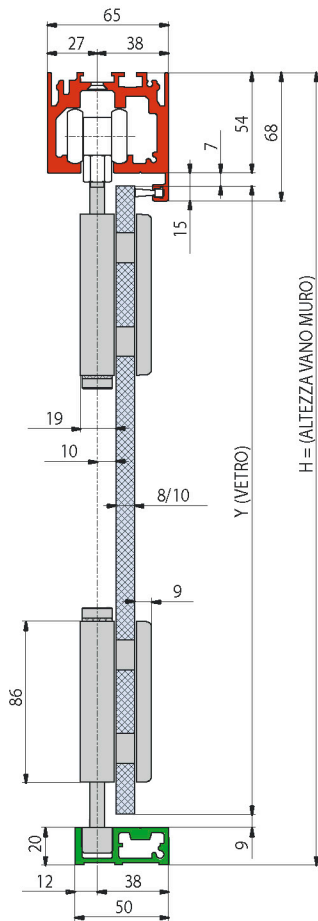
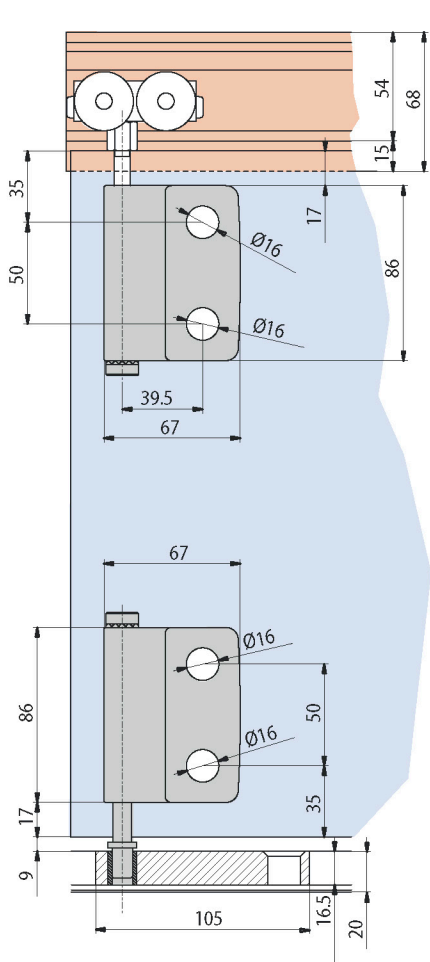

Y = Altezza vetro  
Glass height  
Glashöhe

H = Altezza vano muro  
Opening height  
Einbaulichte Höhe

GUIDA ALLUMINIO INFERIORE INCASSATA  
ALUMINIUM BOTTOM GUIDE  
BODENFÜHRUNG AUS ALUMINIUM







GUIDA ALLUMINIO INFERIORE ESTERNA  
ALUMINIUM BOTTOM GUIDE CLEAR THRESHOLD  
BODENFÜHRUNG AUS ALUMINIUM AUSSEN MONTIERT

$$Y (\text{Vetro}) = H (\text{Altezza vano muro}) - 70$$

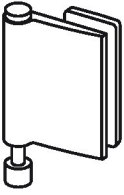
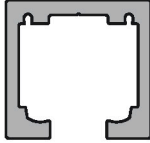
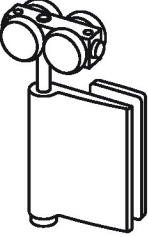
$$Y (\text{Vetro}) = H (\text{Altezza vano muro}) - 90$$

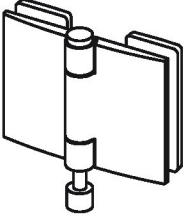
# scorrevole a libro L-1500 / L-2000

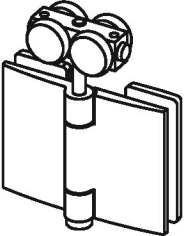
componenti - components - Einzelteile

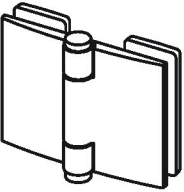
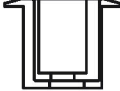
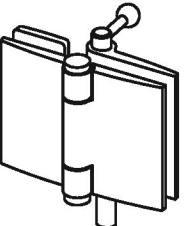
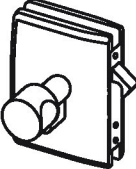
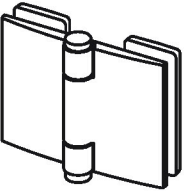
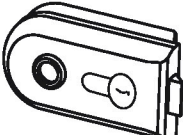
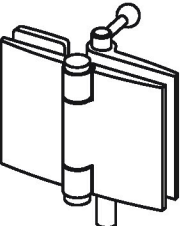
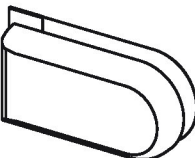
 <p><b>L-201</b> Cerniera laterale inferiore per prima/ultima anta <i>Bottom hinge fitting for first/last panel</i> <i>Unteres seitliches Band für erstes/letztes Element</i></p>	 <p><b>L-150</b> Binario superiore di scorrimento in alluminio <i>Aluminium top track profile</i> <i>Aluminium Laufschienenprofil</i></p>
 <p><b>L-202</b> Cerniera laterale superiore per prima/ultima anta <i>Top hinge fitting for first/last panel</i> <i>Oberes seitliches Band für erstes/letztes Element</i></p>	 <p><b>L-110</b> Guida a pavimento <i>Bottom rail</i> <i>Bodenführung</i></p>
 <p><b>L-203</b> Cerniera inferiore di scorrimento per guida pavimento <i>Bottom sliding hinge for bottom rail</i> <i>Unteres Faltband für Fußboden Führung</i></p>	 <p><b>L-208</b> Fermi per prima/ultima anta <i>Stoppers for first/last panel</i> <i>Endanschläge für erstes/letztes Element</i></p>
 <p><b>L-204</b> Cerniera superiore di scorrimento in guida <i>Top sliding hinge for the track profile</i> <i>Oberes Faltband mit Laufwagen für Laufschiene</i></p>	 <p><b>L-209</b> Pozzetto per cerniera inferiore prima/ultima anta <i>Bottom pivot adaptor for first/last panel</i> <i>Bodenbuchse für erstes/letztes Element</i></p>
 <p><b>L-205</b> Cerniera centrale inferiore/superiore <i>Top/bottom hinge</i> <i>Unteres/oberes Faltband</i></p>	 <p><b>L-111</b> Pozzetto inferiore eccentrico regolabile per perno <i>Floor socket eccentric with adjustable insert</i> <i>Extenterschliess Buchse verstellbar</i></p>
 <p><b>L-206</b> Cerniera inferiore completa di catenacciolo di chiusura (per impacchettamento interno) <i>Bottom hinge fitting with locking bolt (folding inside)</i> <i>Unteres Faltband mit unterer Verriegelung</i></p>	 <p><b>V-504</b> Serratura minima con scrocco a gancio per scorrevole vetro <i>Minima lock with hook for glass sliding door</i> <i>Minima Schloßkasten mit Hakenfalle für Glasschiebetür</i></p>
 <p><b>L-205</b> Cerniera centrale inferiore/superiore <i>Top/bottom hinge</i> <i>Unteres/oberes Faltband</i></p>	 <p><b>V-200</b> Serratura con foro cilindro <i>Lock with cylinder hole</i> <i>Schloss für Profilzylinder</i></p>
 <p><b>L-206</b> Cerniera inferiore completa di catenacciolo di chiusura (per impacchettamento interno) <i>Bottom hinge fitting with locking bolt (folding inside)</i> <i>Unteres Faltband mit unterer Verriegelung</i></p>	 <p><b>V-200 2FLG</b> Controserratura <i>Strike box</i> <i>GegenKasten</i></p>



